

FOR THE RECORD

The model and serial number are found on the back panel. You should record both the model and serial number from the back of the machine for future reference.

Model MINI-CLASSIC

Date of Purchase _____

Serial Number _____

Dealer Name and Phone Number _____

LIMITED WARRANTY

This product is warranted by Pure Water, Inc. to the original user only to be free from defects in materials and workmanship of fabricated stainless steel components for a period of fifteen (15) years from the date of manufacture.

All electrical components are warranted by Pure Water, Inc. to the original user only for a period of two (2) years from the date of manufacture.

Any defective part or parts will be repaired or replaced free of charge during the warranty period when the defective part is returned freight paid to: Customer Service Department, Pure Water, Inc., 3725 Touzalin Ave., Lincoln, NE 68507. The part, or product, will be replaced or repaired at the sole discretion of Pure Water, Inc. and returned to the original purchaser freight collect, unless otherwise instructed.

This warranty specifically excludes subsequent purchasers claims, damage incurred during shipping, abuse, misuse or any damage resulting from the failure of the user to follow manufacturer's directions. No warranty is provided for corrosion of stainless steel parts due to contact with chlorides.

In order for this warranty to be effective, the user must return the warranty card postmarked no later than 10 days from the date of purchase. Other than as stated above, Pure Water, Inc. makes no representation or warranty of merchantability or fitness for a particular purpose.

In no event will Pure Water, Inc. be liable for incidental or consequential damages. This warranty gives you specific legal rights and you may have other rights that vary from state to state.

PURE WATER®

MINI-CLASSIC™

Water Purification System

Owners Manual

3725 Touzalin Ave., Lincoln, NE 68501 USA
Phone: 402-467-9300 • Fax: 402-467-9393

CONTENTS

Congratulations from the President of Pure Water 3

Important Safety Information 3

Use and Care of the Drinking Water Container 4

Electrical Requirements 4

The Use of Extension Cords 4

How Distillation and Your Distiller Work 5

Getting Acquainted With Your Mini-Classic 6-7

Unpacking Your Mini-Classic 8

First Time Start-Up 8-9

Normal Operation 9

Maintenance & Cleaning 10-11

- Maintenance
- Cleaning
- Replacing the Carbon Filter

Troubleshooting 12-13

Ordering Parts and Servicing 13

Individual Parts List 14

Exploded View of Mini-Classic 15

For the Record back cover

Warranty back cover

Exploded View of Mini-Classic

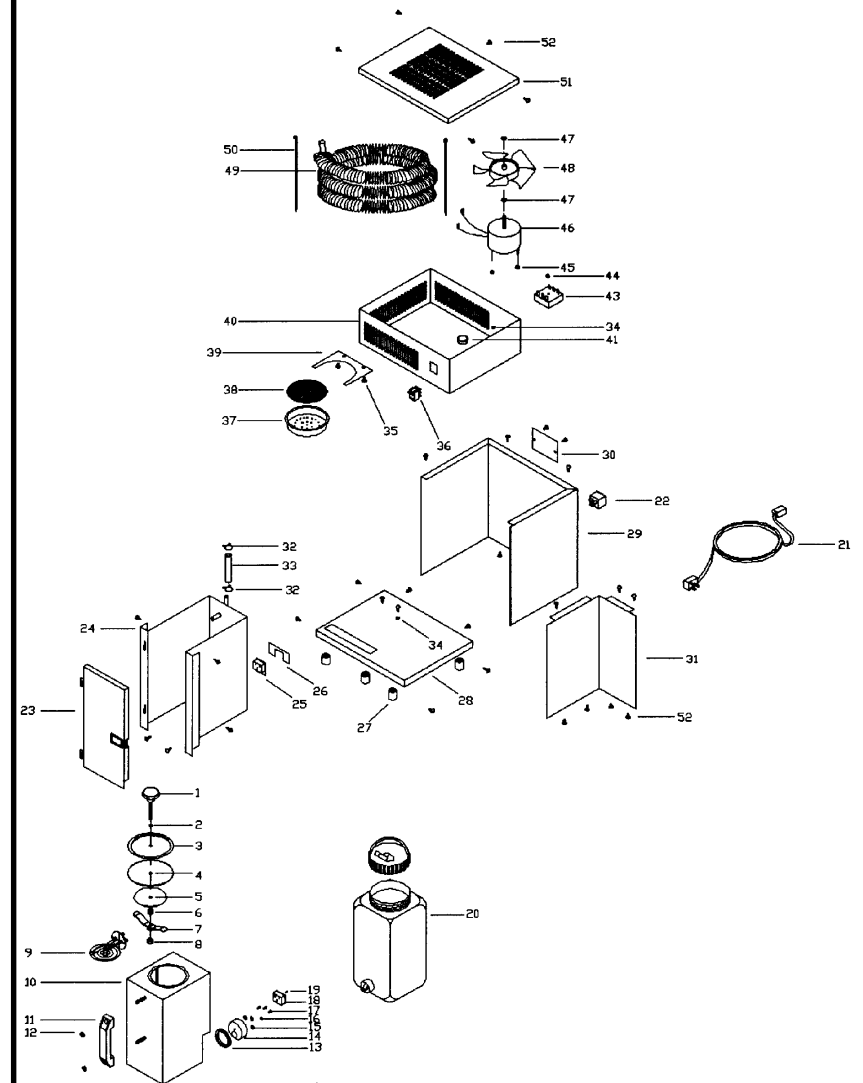

INDIVIDUAL PARTS LIST

Key #	Part #		Description
	120V	240V	
1	8009	8009	Lid Knob w/ Stud
2	6022	6022	Lid O-Ring
3	519	519	Lid Disc S.S.
4	69	69	Gasket, Boiling Tank Lid
5	533	533	Washer, Gasket Retainer
6	9085	9085	Spring, Tank Lid
7	402B-01	402B-01	Crossbar, w/ Nut
8	224-0003	224-0003	Nut, 1/4-20 Nylock
9	9202	9202V	Heating Element, 750W
10	45501A-02	45501A-02	Boiling Tank, Studded
11	9108	9108	Handle, Black Plastic
12	9079	9079	Nut, Acorn, w/ Washer
13	9205	9205	Seal, Silicon
14	9203	9203	Controller, Element
15	9208	9208	Washer, Flat
16	9209	9209	Washer, Lock
17	9207	9207	Screw, M3 x 8
18	9206	9206	Protector Cover
19	9210	9210	Mounting Screw
20	9214	9214	One Gallon Jug w/ Lid
21	7276		Power Cord IEC
22	7275	7275	IEC Connector
23	45512	45512	Door Assembly, Rectangular latch
24	45504B	45504B	Boiling Tank Liner, Welded
25	9204	9204	Element Adapter
26	45006	45006	Clip, Adapter
27	9218	9218	Appliance Feet, 7/8"
28	45503A	45503A	Base, Studded 10/99
29	45008A	45008A	Cladding
30	45009A	45009A	Middle Divider
31	9922	9922	Hose Clamp, Wire
32	9541	9541	Tubing, Silicone
33	9046	9046	Washer, Lock, #10
34	9026	9026	Screw, 1/4-20 x 1/4"
35	9215	9215	Switch, 3-Position, Lighted
36	9213	9213	Filter Cup
37	45518-1	45518-1	Carbon Filter
38	45013	45013	Filter Tray
39	45506B-02	45506B-02	Top Cabinet, Studded 10/99
40	9220	9220	1" Bushing Closed
41	45016	45016	Insulation (not shown)
42	9211	9211V	Timer, 210 Minute
43	9070	9070	Nut, #10-24, Nylock
44	9003	9003	Nut, #8-32, Nylock
45	45517	45517V	Motor, Fan
46	9092	9092	Push Nut
47	9216	9216	Blade, Fan, 6.5"
48	9217	9217	Condensing Coil
49	7246	7246	Wire Tie, Black
50	45014	45014	Top Cover
51	9029	9029	Screw, #10 Sheet Metal
52	45017	45017	Access Panel Cover

CONGRATULATIONS

You've taken an important step to ensure that you and your family have fresh, great tasting high-purity drinking water.

The Pure Water® Mini-Classic™ distiller is built of the finest materials and constructed with care and attention to detail. If you need assistance, please contact your local Pure Water Dealer or Distributor, or call Pure Water, Inc. Customer Service at 1-800-875-5915. I urge you to take time to read and understand the Safety Information section below.

We are sure you will have many years of use from your Pure Water Mini-Classic distiller. If you're thrilled with this product as we expect you will be, why not tell a friend or neighbor?

Thanks for being a member of the Pure Water Family and helping us to "Improve the Quality of Life Through the Quality of Water!"

Al Meder
President

IMPORTANT SAFETY INFORMATION

- ♦ Make sure lid is removed from drinking water container before inserting into holding area, and before unit is turned on.
- ♦ Operate indoors only in a well ventilated area.
- ♦ Always unplug the power before assembling, repairing or doing any work on the distiller.
- ♦ NEVER immerse the distiller in water or any other liquid.
- ♦ NEVER operate the distiller with a damaged cord or allow the cord to become exposed to hot surfaces.
- ♦ NEVER let children play with the distiller.
- ♦ Make sure your electrical outlet is properly grounded. If in doubt, contact a qualified electrician.
- ♦ NEVER remove the boiling chamber from the unit until it has cooled down.
- ♦ The physiological effect of the operation of this appliance, beneficial or otherwise have not been investigated by UL.

USE AND CARE OF THE DRINKING WATER CONTAINER

To ensure proper performance and a lifetime of trouble-free service, please read the following information on general use and care of the drinking water container:

- Do not use on stove-top burner, under heating elements, in microwave or conventional ovens.
- Do not store hot liquids nor food in drinking water container.
- Freezer-safe.
- Do not place base in dishwasher. *Lid:* Dishwasher safe, top rack only.
- Do not use abrasive cleaners or sharp utensils.

ELECTRICAL REQUIREMENTS

The Pure Water Mini-Classic must be plugged directly into a fully grounded outlet.

The Pure Water Mini-Classic will use approximately 8 amps when operating, so isolate a 10 amp fuse or circuit breaker for the unit.

This unit operates on 110V, 60 cycles, or as otherwise specified on the back of the distiller.

THE USE OF EXTENSION CORDS

An extension cord is not recommended. However, an extension cord may be used if care is exercised.

If an extension cord is used:

- a. The marked electrical rating of the extension cord should exceed the electrical rating of the Pure Water Mini-Classic (see the specifications on back of the unit).
- b. The extension cord must be a three-pin grounded type.
- c. The extension cord should not be placed under carpet or left where persons may trip over it.
- d. Do not overload extension cord with other power consumers.

SYMPTOM: There is steam around the unit...

Possible Cause

INSUFFICIENT VENTILATION OF THE UNIT

Check...

- ... that the unit is not pushed hard against the wall. Keep about 1 inch clearance.
- ... if there are any items on the unit that may block the air flow. Remove any such items.

Possible Cause

FAN MOTOR

Check...

- ... if the fan is not turning and you have checked that there is power to the unit, and the power switch is on, then it may be a failed fan motor. Replace the fan motor (stock #45517).

SYMPTOM: There is water around the unit...

Possible Cause

IMPROPER POSITIONING

Check...

- ... that the carbon filter is in proper position and water is flowing through it.
- ... that the drinking water container is correctly placed to catch the water.

ORDERING PARTS & SERVICING

Pure Water recommends that you have your Pure Water Mini-Classic serviced by an authorized service center. Please see your Pure Water Dealer or Distributor.

If you require parts or accessories at any time, please contact your Pure Water Dealer or Distributor. In the unlikely event your Pure Water Dealer or Distributor cannot help, you may contact Pure Water, Inc. Customer Service at 800-875-5915.

To help you identify parts for your Pure Water Mini-Classic please see the parts list included in this manual on page 14.

TROUBLESHOOTING

The Pure Water Mini-Classic distiller is designed for years of dependable service. The following guide is presented to assist you in the event of any problems with your product.

SYMPTOM: Unit does not produce water...

Possible Cause

NO POWER

Check...

- ... that the power cord is plugged in and is pushed in completely to back of machine.
- ... that the power to your home/office is on.
- ... that the power switch (11) is turned on. The switch must be completely depressed at the top to initiate operation.
- ... that there is water in the boiling chamber.
- ... that the boiling chamber (1) is completely pushed in.

Possible Cause

HEATING ELEMENT BURNED OUT

Check...

- if there is power to your home/office...
- if the power cord is plugged in...
- if the power switch is turned on...
- if the boiling chamber is pushed in completely, and the fan rotates when the unit is on, but the air is cool, or cold...

Then...

Replace the heating element (stock #9202).

SYMPTOM: The distilled water has a taste...

Possible Cause

NEW CARBON FILTER NEEDED

Action...

- ... change post filter by following directions for Replacing the Carbon Filter on page 11.
- ... thoroughly clean the boiling chamber.
Note: Make sure the boiling chamber is cool.

HOW DISTILLATION AND YOUR DISTILLER WORK

Nature has a way to produce pure water from contaminated sea water (1). When the sun rises in the morning, it starts to heat the surface of the ocean (2). The heat causes molecules or pure water to escape from the surface of the ocean (3) and rise to form clouds (4). When the conditions are right, (5) the clouds cannot hold any moisture and water falls to earth as rain (6). The rain collects in rivers, lakes and reservoirs and is available for drinking (7).

NATURE'S DISTILLATION CYCLE...



THE PURE WATER WAY...

A distiller operates the same way. Water is taken into a boiling chamber (1) where heat is applied (2). The water boils and water molecules (steam) rise (3). The steam enters the condenser (4) where cool air (5) causes the steam to lose energy and it forms droplets of pure water (6). This water is collected and is fresh, great-tasting, distilled drinking water (7) - the purest kind.

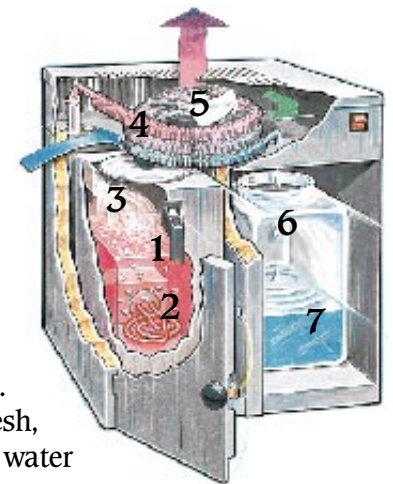

GETTING ACQUAINTED WITH YOUR MINI-CLASSIC

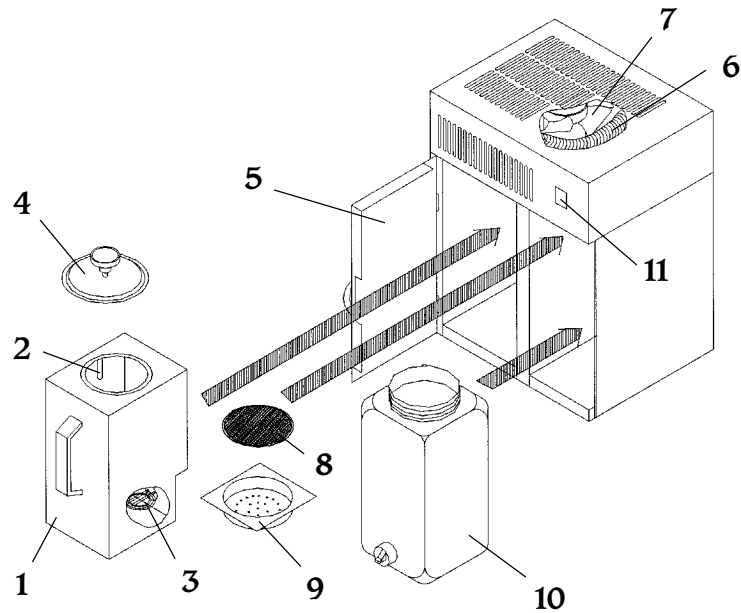

COMPONENT IDENTIFICATION

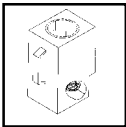

Boiling Chamber (1). The manually-filled stainless steel boiling chamber holds one gallon of water when filled to the proper level.

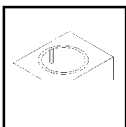

Water Level Indicator (2). A small rod which extends down inside the boiling chamber. The boiling chamber should be filled to touch the bottom of this indicator.

CAUTION: DO NOT overfill.



Heating Element (3). The 750-watt heating element provides the heat to boil the water in the boiling chamber.

To Clean the Boiling Chamber:

1. Turn the power switch to the OFF position.
2. If the unit has been operating, allow it to cool for 30 minutes from the end of the distillation cycle.
3. Carefully remove the boiling chamber from the unit.
CAUTION: The boiling chamber will get hot and could cause a burn if the unit has not been allowed to cool.
4. Remove the boiling chamber lid (4).
5. Drain any residual water inside the boiling chamber (1).
6. Fill the boiling chamber to the water level indicator (2).
7. Add Lumen™ Cleaner (stock #6603) to the boiling chamber. Follow instructions on the label.

Note: DO NOT replace the boiling chamber back into the unit during the cleaning process DO NOT allow the unit to operate with the Lumen Cleaner in the boiling chamber.

• Replacing the Carbon Filter

A carbon filter (9) is used to *finish* or *polish* the water, and to improve the taste. The carbon filter should be replaced approximately every 3 months, or whenever the water develops a taste. The carbon filter is custom designed for the Pure Water Mini-Classic distiller.

To Replace the Carbon Filter:

1. Remove the drinking water container (10) from the unit.
2. Remove the old filter by sliding the filter housing (9) and filter (8) towards you or removing it from the opening in the drinking water container.
3. Immerse the new carbon filter (9) in a separate container filled with **distilled** water for one minute.
4. Remove the soaked filter and place it into the filter housing.
5. Slide the new filter and housing back into the guide or replace it into the opening of the drinking water container (9).

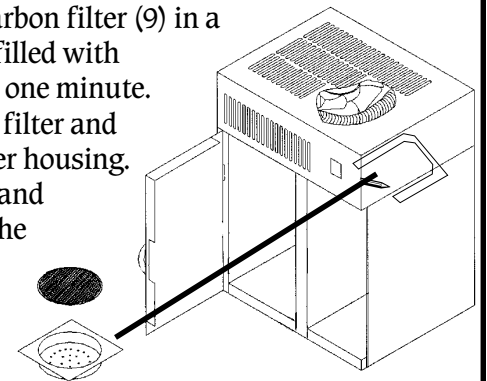

MAINTENANCE & CLEANING

With proper care on your part, your Mini-Classic will provide you with high-quality water for many trouble-free years.

The following recommendations are for typical water conditions. If you live in an area where the water quality is exceptionally poor, you may need to increase the frequency of our care.

• Maintenance

Every Batch:

- Swirl and rinse out the residual water from the boiling chamber (1).

Monthly, or every 30 gallons:

- Clean the inside of the boiling chamber (1) to remove any build-up of solid residues. (See *Cleaning* below).

Every 3 months:

- Replace the carbon filter, stock #45518. (See page 9).
- Clean the exterior with Stainless Steel Cleaner & Polish, stock #6606.

• Cleaning

Cleaning the Exterior:

Use Stainless Steel Cleaner & Polish (stock #6606) and follow instructions.

Cleaning the Boiling Chamber:

Sometimes scale will build up inside the boiling chamber. This needs to be removed periodically to ensure good heating element life, and high-quality drinking water.

Note: If you rinse the boiling chamber every time you fill it, you will rarely get build-up of scale inside the boiling chamber, and will rarely have to clean it.

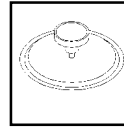

Lid (4). The lid is constructed of heavy-gauge stainless steel and has a special gasket and handle which tightens to seal.

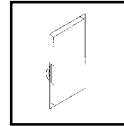

Door (5). The hinged stainless steel door improves the look of the unit and serves an important safety role. DO NOT open the door until the unit has stopped distilling for a minimum of 30 minutes.

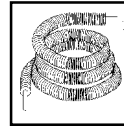

Condenser (6). A hollow, finned stainless steel tube where the steam from the boiling chamber is collected and cooled by the air from the fan. The steam is converted into high-purity drinking water. At the top portion of the condensing coil there are two small holes. These are gas vents to allow volatile compounds to escape.

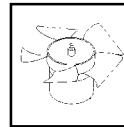

Fan (7). An electrical fan which works automatically to provide a flow of air across the outside of the condenser.

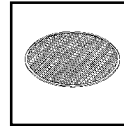

Filter (8). Before the distilled water flows into the drinking water container, it passes through a carbon filter pack to *polish* the taste of the water.

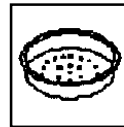

Filter Housing (9). An FDA approved food-grade housing designed to slide into the guides in the distiller and holds the carbon filter pack.

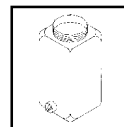

Drinking Water Container (10). This FDA-approved food-grade PET plastic container collects the distilled water. It is equipped with a spigot for ease of use.

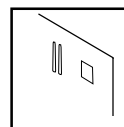

Power Switch (11). The power switch is located on the front of the unit. It is a 3-position switch. The top position is ON, and when pushed and released, it automatically resets to the center for operation. The bottom position is OFF.

UNPACKING YOUR MINI-CLASSIC

Your Pure Water Mini-Classic water purification system is shipped to you in a durable carton. Carefully remove the contents from the box.

The Pure Water Mini-Classic carton contains:

- The Pure Water Mini-Classic distiller.
- Food-grade plastic container and lid.
- Filter kit.
- Owners Manual and Warranty Card.
- Power Cord (Not included in 240 Volt machines).

If these are not present, please look for the Quality Assurance Inspection Slip and note the name of the inspector. Call your Dealer or Distributor; or, in the event you can't reach them, contact Pure Water, Inc. Customer Service Department at 800-875-5915 (outside the USA, please call 402-467-9300).

Note: Save the box and packing materials for future use in the unlikely event your Mini-Classic should require service work.

FIRST TIME START-UP

Starting the unit for the first time:

1. Open the door (5) and remove the boiling chamber (1) by pulling on the handle.
2. Remove the lid (4) by turning the black lid knob counter-clockwise and moving the lid (4) side to side and lift out.
3. Fill the boiling chamber (1) with tap water until the water touches the bottom of the water level indicator (2). DO NOT overfill.
4. Replace the lid (4) on the boiling chamber (1). Turn the black lid knob clockwise and tighten firmly, ensuring a good seal. DO NOT overtighten.
5. Push the boiling chamber (1) into the left side of the distiller until it fits snug and the element prongs plug into the controller.
6. Close the door.

Note: DO NOT install the post filter at this time. Keep the first batch of distilled water for soaking the post filter.

First Time Start-Up Continued...

7. Put the drinking water container in place.
8. Plug the power cord into the back of the machine and then into the electrical source.
9. Turn the power switch (11) to START .
10. Allow the unit to operate until it automatically shuts off (approximately 4 hours).
11. Keep the first batch of distilled water for soaking the post filter as described in the next section, but do not drink.
12. Replace the drinking water container (10) to the distiller.

NORMAL OPERATION

1. Ensure that the boiling chamber is cool.
2. Open the door (5) and remove the boiling chamber (1) by pulling on the handle.
3. Loosen the black knob on the lid (4) and slide the lid from side to side and lift the lid out.
4. Swirl and empty out any water left in the boiling chamber (1) from the prior batch.
5. Fill the boiling chamber (1) with tap water until it touches the bottom of the water level indicator (2).
6. Place the lid (4) on the boiling chamber (1). Tighten the black lid knob firmly, ensuring a good seal. DO NOT overtighten.
7. Push the boiling chamber (1) into the left side of the distiller until it fits snug and the element prongs plug into the controller. Close the door.
8. Submerge the filter (8) completely in a separate container with **distilled** water for one minute. Remove the filter (8) and place inside the filter housing (9).
9. Slide the filter housing (9) into the guide above the drinking water container.
10. Be sure lid is removed from container. Put the drinking water container (10) in place.
11. Turn the power switch (11) to START. **Note:** To activate the unit, the switch must be fully depressed.
12. Allow the unit to operate until it automatically shuts off. This will take approximately 4 hours.

CAUTION: Never open the door during operation and never remove the boiling chamber while the unit is operating.